



## Product Demonstration

Portable Air Conditioner **PC-AMF**



## ○ Product Category | Portable Air Conditioner



**(Cooling & Heating, 7000~14000 Btu/H)**

### Features

- Cooling+ Heating+ Dehumidifying + Ventilating in 1 unit
- 4-Steps fan speed control
- Smart program with sleep mode
- 24-Hrs timer for auto on/off
- Simple installation: plug to use
- Waterproof design (IP24): able to place outdoor
- Optional accessories: window kits

### Design

- Front & Back air outlet interchanging design, cleverly use the cold & hot air in different way.
- Self-Evaporating technique: free from draining and dipping.
- Build-in exhaust hose: Save the space and prevent the dust.
- Diverse control panels: mechanical, electronic, touch pad, sliding-knobs



# More Options



PC-AMA

PC-AMB

PC-AMD

PC-AME

PC-AMF

PC-AMH



# Versatile Air Conditioner

Cooling  
Heating  
Dehumidifying  
Ventilating

Clothes Drying  
Blanket Warming  
Basement Refreshing  
Kitchen Air Conditioning

Model	PC-AME2	PC-AME
Capacity (BTU)	7,000~10,000	12,000~14,000
Dehumidification	40 L/ Day	60 L/Day
Air Volume	360 m <sup>3</sup> /Hr	450 m <sup>3</sup> /Hr
Noise	< 65 dB	< 65 dB
40'HQ Container Loading	443pcs	318pcs





## MAIN FEATURES



Air Conditioning



60L Dehumidification



3-Speed Fan



Strong warm air

- Non-Draining A/C: Self-Evaporating
- Simple Installation: Plug-to-use
- Built-In Duct: Good for package & storage
- Multiple application: cold & warm air connection
- Optional Purification: TiO<sub>2</sub> & Ion(Ag<sup>+</sup>) filters





# Non-Dripping A/C

Self-Evaporating technique

With Self-Evaporating technique, we construct a ultimate internal circulation. Effectively use the condensation to decrease the heat of internal parts which helps saving the power and solving the water drainage problem.



## **Self-Evaporation**

Non-Dripping, No Leakage,  
and Easy Moving

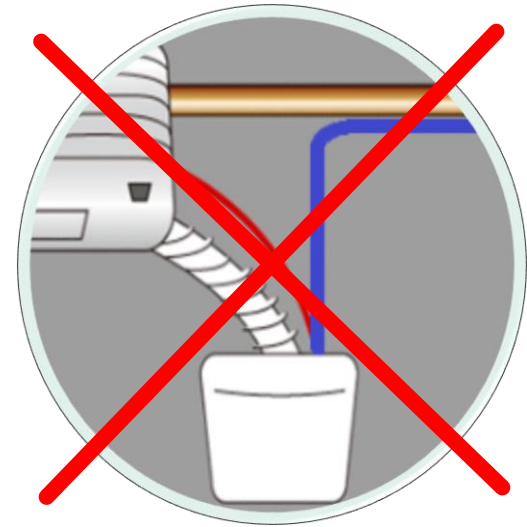

## **General A/C**

Draining System  
and ugly pipes

## Power Saving A/C Self-Evaporating Technology

Evaporate the condensation and flow out through the exhaust hose, which makes the portable air conditioner free from draining.

Moreover, the condensation helps decrease the heat of inner parts, which improves the cooling efficiency and save the power.

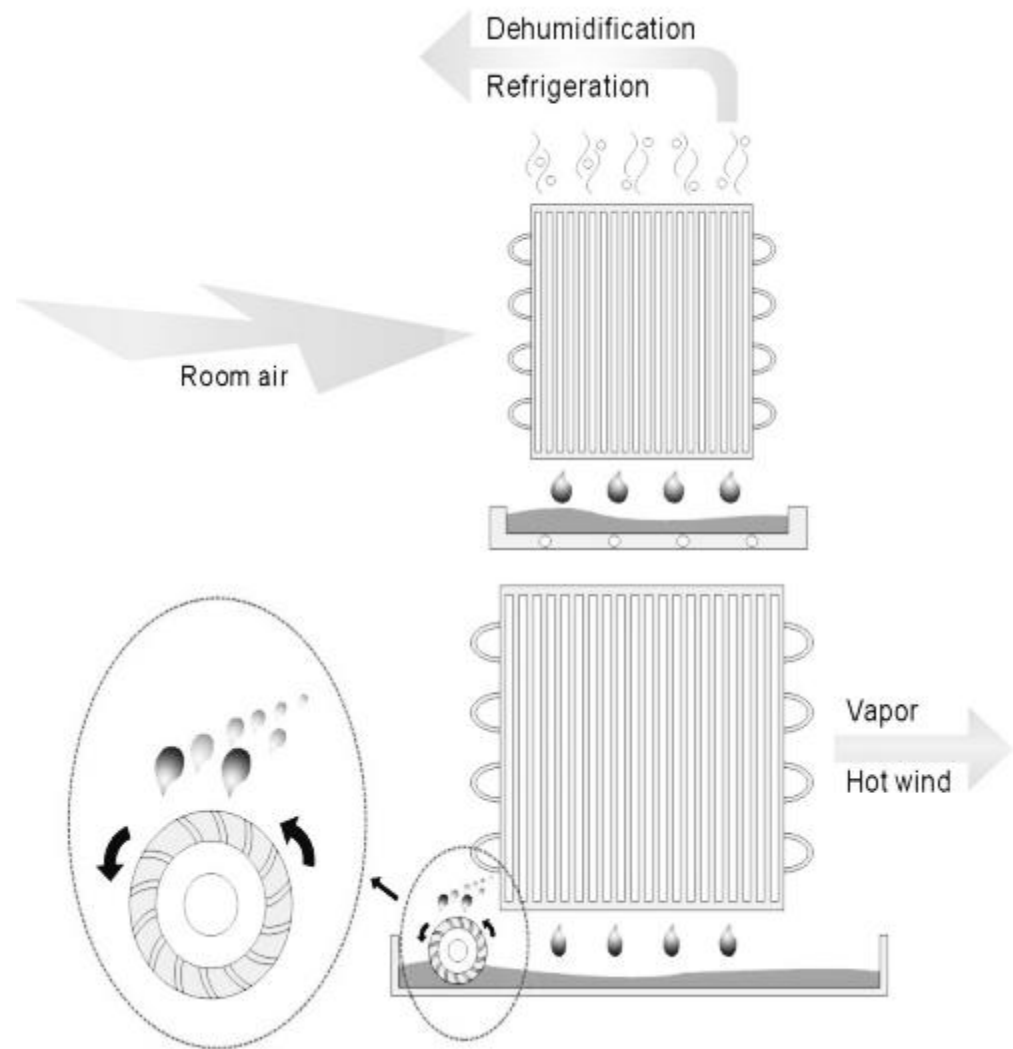



## Elegant Panel

Tired of the common design of the panel. Let's try something new!

## Simple and Neat

Use simple icons for users to control, leave rest of the space logo or branding/ promotion material.







## Supreme air volume: 360m<sup>3</sup>/Hour

Two fan motors and extra large air inlet effectively improve the indoor air circulation, speed-up the room cooling and refreshing.

- Optional air filters to upgrade the air purification:  
TiO<sub>2</sub> & Ion (Ag<sup>+</sup>)

## Built-In Duct Design

- Easy to pack the unit
- Save the storing space
- Good looking



1. Innovative built-in exhaust hose of duct
2. Easy to store & pack
3. Better looking
4. Exclusive design with patent

### Patent highlight

(No. : ZL 2007 2 0053098.2)

No. : ZL 2007 3 0056477.2)

# Benefit of Built-In Duct Design



## United

- Self-Storable
- Better looking

V.S.



## Other Brands

- Messy
- Occupy Space



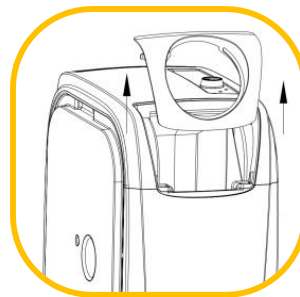

## Interchangeable Air Outlet

1. Interchangeable vent & exhaust hose adapter
2. Can place in outdoor
3. Exclusive design with patent

## Benefit of Interchangeable Cooling & Heating Air Outlet



- Enjoy Cooling mode in summer and Heating mode in winter
- Blade for leading the air flow, improving the air cycle
- tube for exhausting the air outside the room
- Cooperate with the unique window kits, put the unit outside and then guide the air into the room, generates multiple applications!

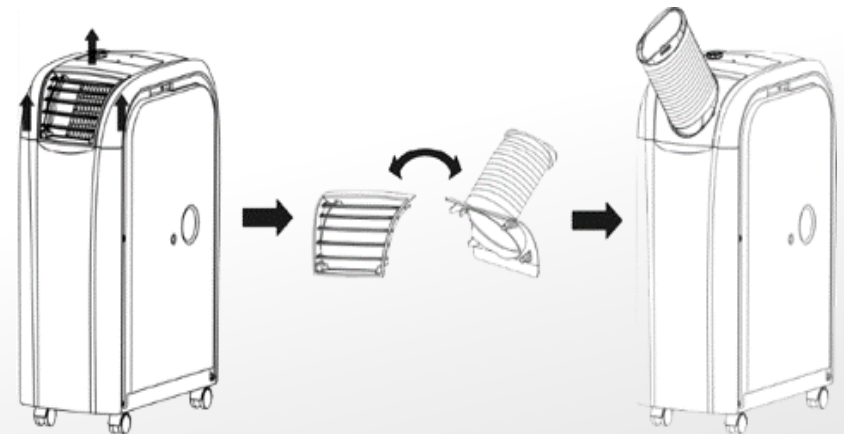





## Waterproof Design

Place the unit outside



## Window Kits Connection

Place the unit outside



The waterproof casing and structure design protect the unit from raindrops and dusts.

Let users place the unit outside (balcony, yard) and enjoy the cold/warm air indoor without noise while connecting window kits (especially C&D).

- Eliminate the noise
- Save the space indoor
- Improve the user experience (Remote unit indoor with C&D type)

## Creative Window Kits

Enlarge user's convenience

A

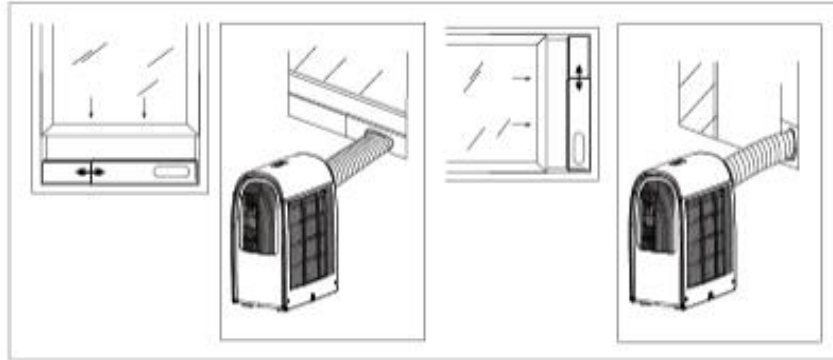

B

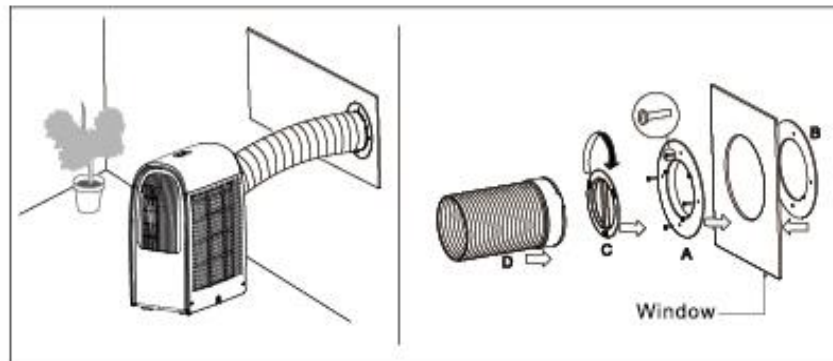

## Creative Window Kits

Electronic type, available to connect with remote control.  
Enlarge user's convenience

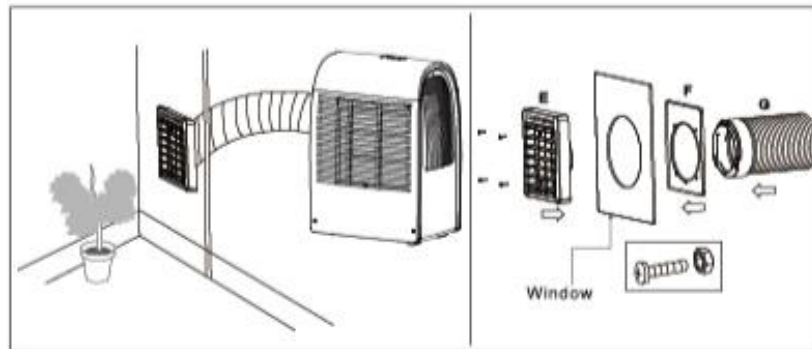
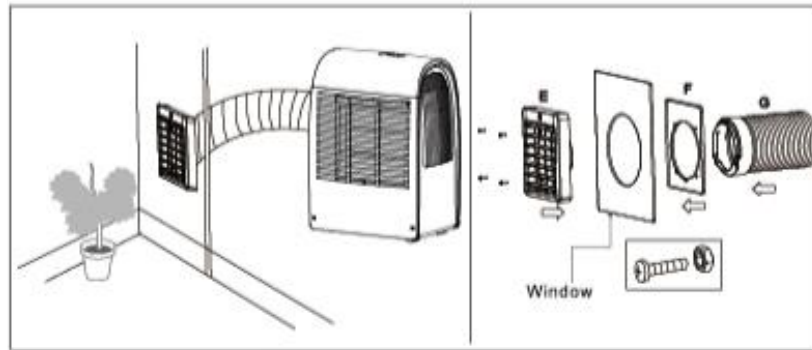

## Benefit of Window Kit (Type C & D)



### Creative Window Kits

Enlarge user's convenience

### Patent highlight

(No.: 200720058411.1)

## Design Point

1) Transform a common accessory to an ultimate product. Enlarge the control convenience and extend the creativeness of our multiple application.

2) Dual exhaust hose connection to utilize both cold & warm air. **Share-Using** the same unit at the same time but different room!

## Applications

Put the unit in room A and use the kit in room B.

- ◆ Bedroom Air Conditioning | Toilet Dehumidifying
- ◆ Blanket warming | Corridor ventilating
- ◆ Balcony clothes drying | indoor mute cooling/heating
- ◆ Rainy days drying closet | Shoes drying with hose





# Accessories

- **Smart Remote**

- ✓ Wi-Fi control available
- ✓ Simple UI
- ✓ Fast pairing
- ✓ Guest sharing







# Features



**Smart Remote**  
Wi-Fi Control

## Smartify Your Home:

Integrate and upgrade your appliances! Use smart remote to transform traditional appliances(control with infrared ray in room) to smart appliances(control with Wi-Fi signal anytime & anywhere).

# Goals to achieve

## □ Protect your home & your health

Makes your health & happiness simpler

## □ Improve the air quality better

Various functions for multiple seasons,  
Different application to utilize the performance

## □ Meaningful Creative

Design to solve the problem,  
Improve to change the life.





**We promise,**

**To Create New Business  
&  
To Expand Bigger Future**



**United International Co, Ltd.**

【Address】 12F, No. 520, Sec.4, Jen-Ai Road, Taipei, Taiwan

【Phone】 +886(02) 2720-5102

【E-Mail】 [Bella@mail-airmaster.com.tw](mailto:Bella@mail-airmaster.com.tw)